

F 015 651 021

Stand } 13-09
Issue } 13-10-14

Fig./Abb. 1

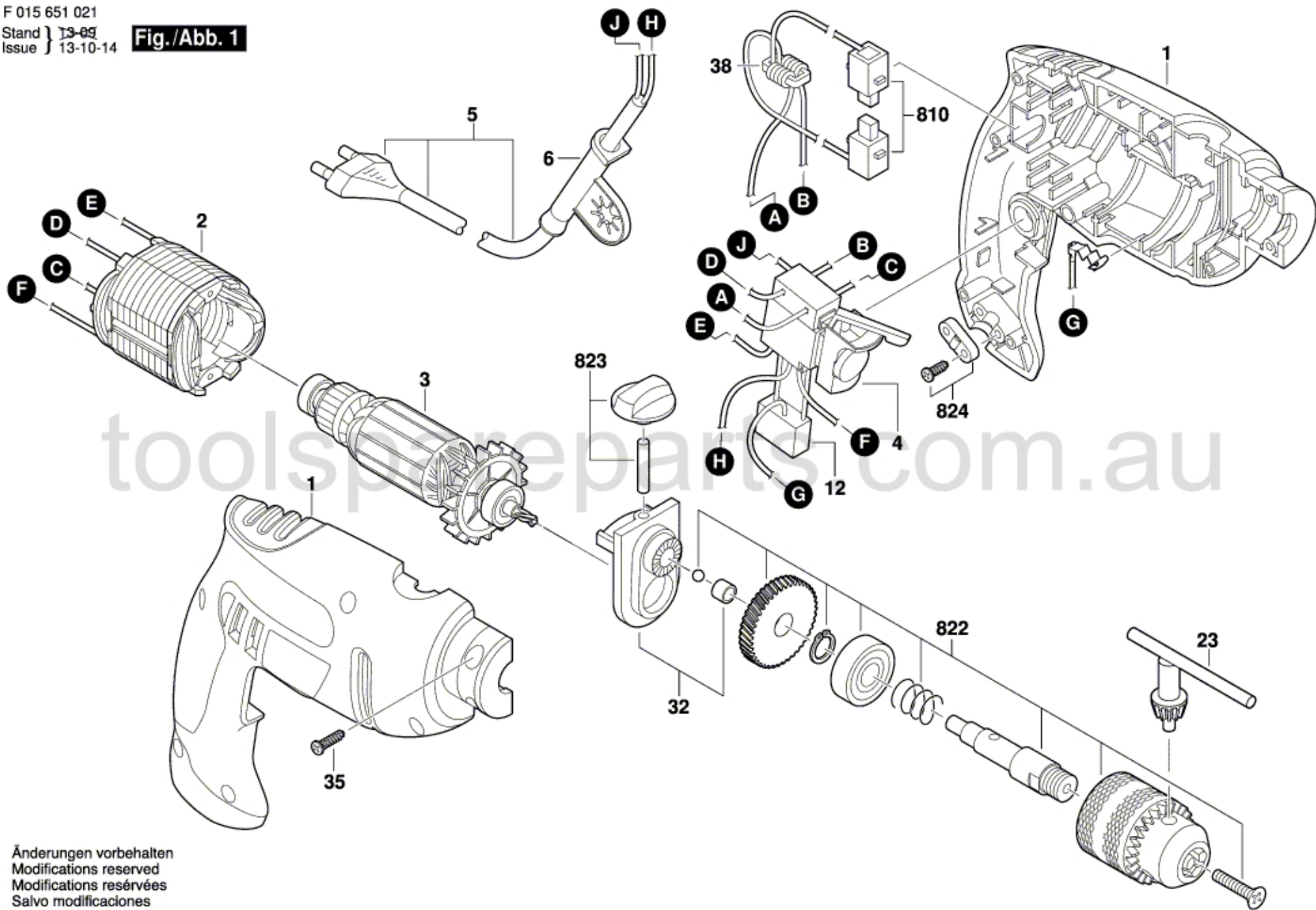

Änderungen vorbehalten
Modifications reserved
Modifications réservées
Salvo modificaciones